

**Features:**

- 4 ~ 16 circuits available
- Material: Nylon 9T, UL 94V-0

**Specification:**

- Current rating: 4.5A AC, DC
- Voltage rating: 250V AC, DC
- Insulation resistance: 1000MΩ Min.
- Dielectric withstanding voltage: 1500V AC/minute
- Ambient temperature range: -40°C ~ 105°C

**Dimensional Information ( mm )**

Circuits	Dim. A	Dim. B
N	1.25 x N - 2.5	1.25 x N + 2.7

&& N = 4 ~ 16

**Ordering Information**

Part No.	Color	Mating part: Headers
H2531-XXPDBB00R	Black	W2531-XXPDSTNBGR / W2531-XXPDRTNBGR
H2531-XXPDBC00R	Natural	W2531-XXPDSTNCGR / W2531-XXPDRTNCGR

&& xx = 04 ~ 16

H2531-XXPDBB00R ↓

H2531-XXPDBC00R ↓ :

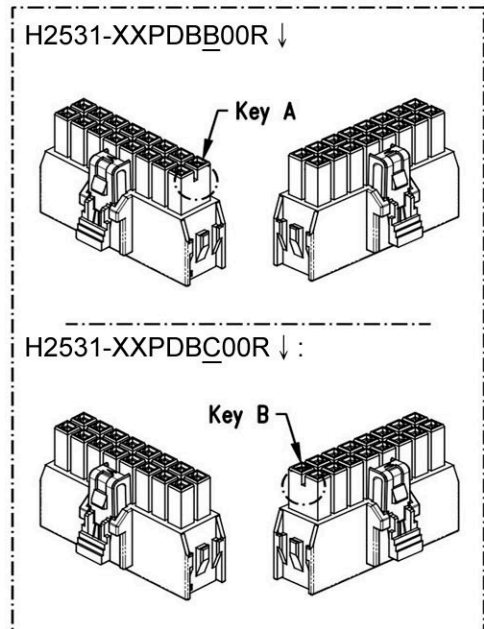
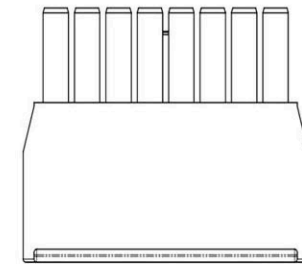
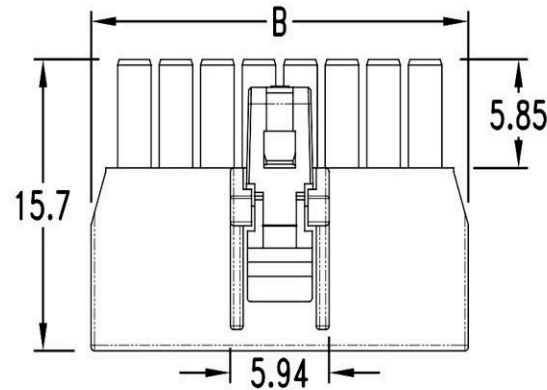
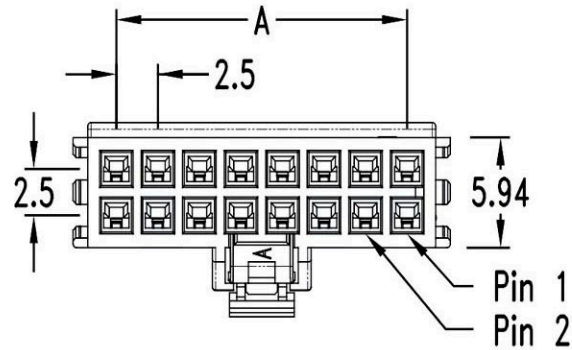
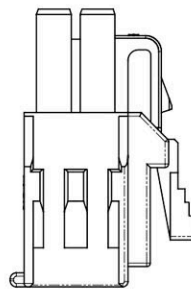
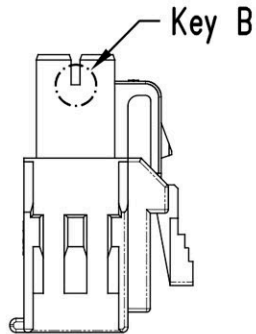
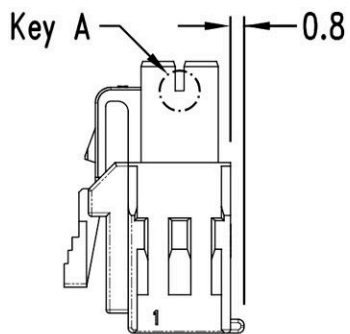

<p><b>RoHS Compliant</b></p>		<p><b>HSM 玄茂科技股份有限公司</b> <b>HSUAN MAO TECHNOLOGY CO., LTD.</b></p>	
<p>APPD. 核准</p>	<p>SCALE 比例 参考</p>	<p>TOLERANCE 容許公差 0 ± 0.35 .00 ± 0.25 ANG. ± 3°</p>	<p>PART NAME 品名 Nano-Fit 2.5mm Female Housing Dual Row 2X??Pin Material:Nylon 9T ROHS</p>
<p>DWG. 製圖 Helen</p>	<p>UNIT 單位 MM</p>	<p>SIZE 紙張尺寸 A4</p>	<p>PART NO. 料號 H2531-XXPDBX00R</p>
<p>DATE 制表日 2019/9/27</p>	<p>PAGE 張數 1 OF 1</p>	<p>REV. 版本 A</p>	