

Signal Segment			
Pin NO.	Type	Name	Type
S1	Signal Ground	S8	Signal Ground
S2	TP+	S9	TS+
S3	TP-	S10	TS-
S4	Signal Ground	S11	Signal Ground
S5	RP-	S12	RS-
S6	RP+	S13	RS+
S7	Signal Ground	S14	Signal Ground

Power Segment			
Pin NO.	Type	Name	Type
P1	V33	P9	V5
P2	V33	P10	Ground
P3	V33	P11	Ready Led
P4	Ground	P12	Ground
P5	Ground	P13	V12
P6	Ground	P14	V12
P7	V5	P15	V12
P8	V5		

NOTES:

- Material:**
 Housing: LCP+50%G.F, UL 94V-0 Rated.
 Color: Black.
 Contact: Phosphor Bronze.
 Plating: Gold Plating over Nickel on Contact Area.
 Tin Plating on Solder Tail.
 Harpoon: Phosphor Bronze.
 Plating: Tin Plating over Nickel.
- Mechanical:**
 Insertion Force: 25N Max.
 Withdrawal Force: 5N Min.
 Durability: 500 Cycles
- Electrical Specification:**
 Current Rating: 1.5 Ampere per Contact.
 Contact Resistance: 30mΩ Max.
 Insulation Resistance: 1000MΩ Min.
 Dielectric Withstanding Voltage: 500 VAC.
- Environmental:**
 Operating Temperature: 0°C to +55°C

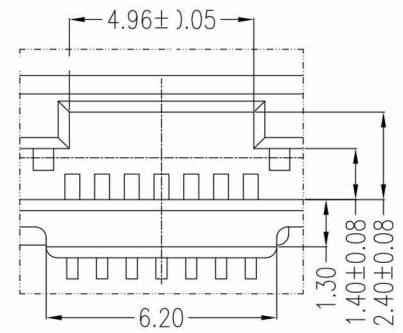
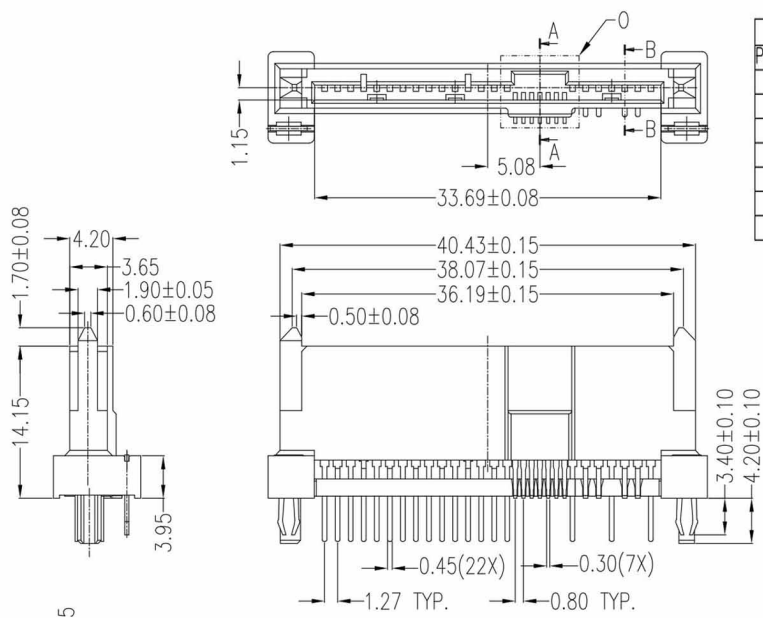

VIEW 0
SCALE 3:1

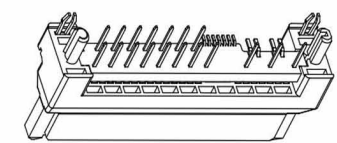
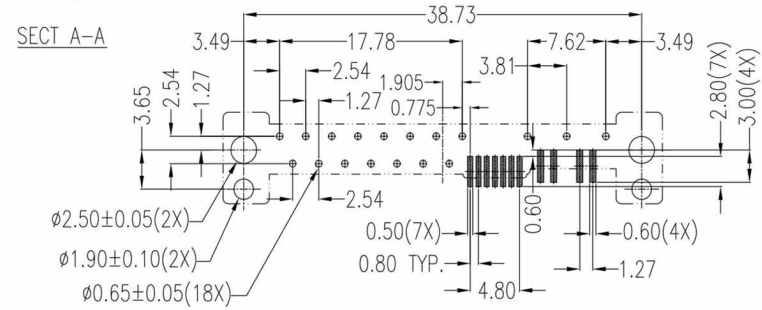
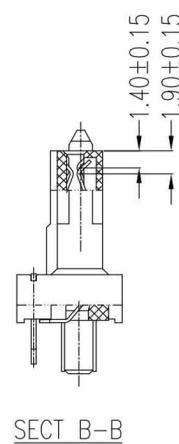
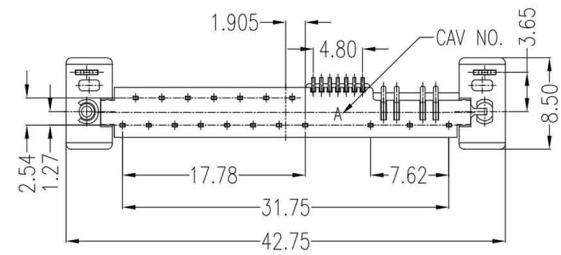
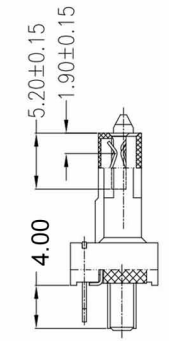

RoHS Compliant		HSM 玄茂科技股份有限公司 HSUAN MAO TECHNOLOGY CO., LTD.	
APPD. 核准 Betty	SCALE 比例 参考	UNLESS OTHERWISE SPECIFIED DIMENSIONS ARE IN MM TOLERANCES ARE: DECIMALS ANGLES X ± .30 ± .3° XX ± .25 XXX ± .20	PART NAME 品名 SAS CONNECTOR 29P(7+7+15) FEMALE DUAL ROWS DIP+SMT TYPE H=15.85mm DIP LENGTH:4.0mm WITH BOARDLOCK & WITH LOCATING PEG BLACK COLOR(MATERIAL:LCP) ROHS
DWG. 製圖 Betty	UNIT 單位 M M	SIZE. 紙張尺寸 A 4	PART NO. 料號 C7207-29F2BXBAR
DATE 制表日 2013/07/11	PAGE 張數 1 OF 1	REV. 版次 A	