

1 2 3 4 5 6 7 8

A
B
C
D
E
F
G
H

A
B
C
D
E
F
G
H

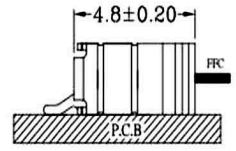
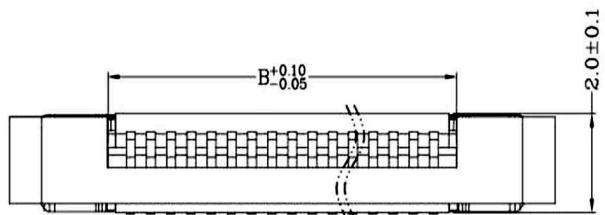

安装图
Assembly Layout

NOTE:
MATERIAL AND FINISH
 HOUSING:HIGH-TEMP. THERMOPLASTIC. UL 94V-0.
 ACTUATOR:HIGH-TEMP. THERMOPLASTIC. UL 94V-0.
 CONTACT:COPPER ALLOY.
 PLATING:TIN OR GOLD PLATED OVER NICKEL.
 HOLDDOWN:COPPER ALLOY. PLATING:TIN PLATED OVER NICKEL.
ELECTRICAL
 CURRENT:0.5A MAX.
 DIELECTRIC WITHSTANDING VOLTAGE:250V AC MIN.
 CONTACT RESISTANCE:30mΩ MAX.
 INSULATION RESISTANCE:100MΩ MIN.
ENVIRONMENTAL
 TEMPERATURE:-20°C TO +85°C
 WITH "A","B","C","D","O" MAJOR DIMENSION FOR QC.

尺寸 mm	A	B	C	D
4	1.50	2.60	7.60	6.50
5	2.00	3.10	8.10	7.00
6	2.50	3.60	8.60	7.50
7	3.00	4.10	9.10	8.00
8	3.50	4.60	9.60	8.50
9	4.00	5.10	10.10	9.00
10	4.50	5.60	10.60	9.50
11	5.00	6.10	11.10	10.00
12	5.50	6.60	11.60	10.50
13	6.00	7.10	12.10	11.00
14	6.50	7.60	12.60	11.50
15	7.00	8.10	13.10	12.00
16	7.50	8.60	13.60	12.50
17	8.00	9.10	14.10	13.00
18	8.50	9.60	14.60	13.50
19	9.00	10.10	15.10	14.00
20	9.50	10.60	15.60	14.50
21	10.00	11.10	16.10	15.00
22	10.50	11.60	16.60	15.50
23	11.00	12.10	17.10	16.00
24	11.50	12.60	17.60	16.50
25	12.00	13.10	18.10	17.00
26	12.50	13.60	18.60	17.50
27	13.00	14.10	19.10	18.00
28	13.50	14.60	19.60	18.50
29	14.00	15.10	20.10	19.00
30	14.50	15.60	20.60	19.50
31	15.00	16.10	21.10	20.00
32	15.50	16.60	21.60	20.50
33	16.00	17.10	22.10	21.00
34	16.50	17.60	22.60	21.50
35	17.00	18.10	23.10	22.00
36	17.50	18.60	23.60	22.50
37	18.00	19.10	24.10	23.00
38	18.50	19.60	24.60	23.50
39	19.00	20.10	25.10	24.00
40	19.50	20.60	25.60	24.50
41	20.00	21.10	26.10	25.00
42	20.50	21.60	26.60	25.50
43	21.00	22.10	27.10	26.00
44	21.50	22.60	27.60	26.50
45	22.00	23.10	28.10	27.00
46	22.50	23.60	28.60	27.50
47	23.00	24.10	29.10	28.00
48	23.50	24.60	29.60	28.50
49	24.00	25.10	30.10	29.00
50	24.50	25.60	30.60	29.50
51	25.00	26.10	31.10	30.00
52	25.50	26.60	31.60	30.50
53	26.00	27.10	32.10	31.00
54	26.50	27.60	32.60	31.50

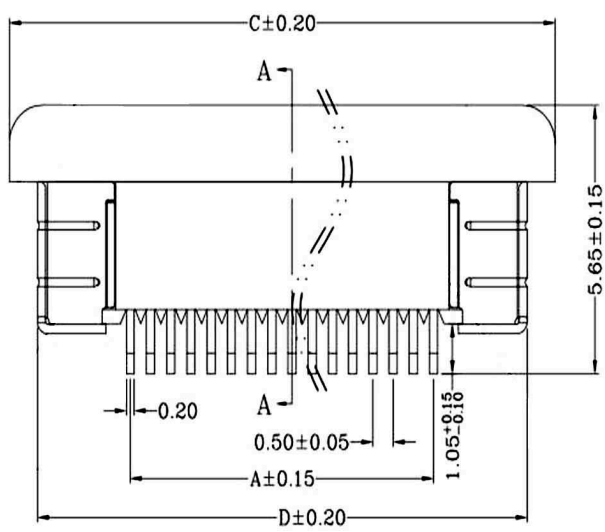

SEC:A-A

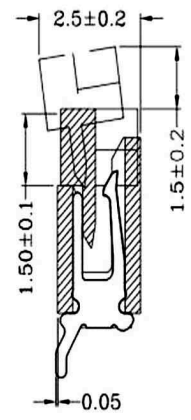

U:Upper Contact

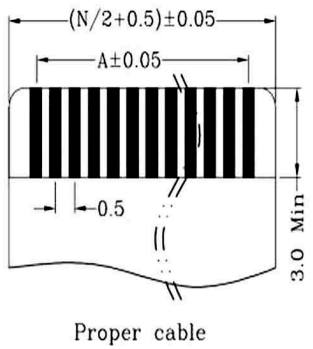
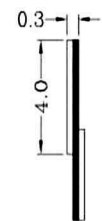
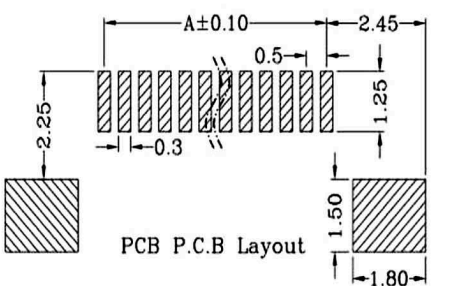

Proper cable

RoHS Compliant		HSM 玄茂科技股份有限公司 HSUAN MAO TECHNOLOGY CO., LTD.	
APPD. 核准	SCALE 比例 参考	TOLERANCE UNSPECIFIED LINEAR ANGLES X ±0.30 X' ±	PART NAME 品名 FPC/FFC ZIF 0.5mm SMT TYPE HORIZONTAL TYPE XXPIN UPPER CONTACT TIN PLATING IVORY COLOR ROHS
DWG. 製圖 Betty	UNIT 單位 M M	SIZE. 紙張尺寸 A 4	PART NO. 料號 C3936-XXUTX100R
DATE 制表日 2016/10/13	PAGE 張數 1 OF 1	REV. 版次 B	

1 2 3 4 5 6 7 8